



7512i MDB Installation Guide

GENERAL INFORMATION

This document contains information for installing the MEI CASHFLOW™ 7512i coin manager.

- 7512i Multi-Drop Bus (MDB)

This product fits into the standard coin changer channel provided by vending machine manufacturers. It mounts on the existing three mounting studs/screws located in the vending machine.

The features of the Coin Manager include:

- Changeable/configurable coin cassette
- Five auto-replenishing coin cubes (flexibility)
- \$1 coin payout
- LCD display panel - gives instant status of unit
- Patented coin inventory recognition
- MDB interface
- Ability to manage coin inventory to minimum levels

Interface

MEI CASHFLOW™ 7512i operates in machines that support the MDB interface*. MDB is a serial communication interface standard that has migrated into vending equipment since 1996. It allows for multiple devices to be added to a single connection on the vending machine control board, by linking one device to another in series to the main MDB harness.

Rated Operating Voltage

Voltage: 34v d.c. 12W

The operating voltage of a MEI CASHFLOW™ 7512i coin manager is stated on the label of each product. The label is located on the left side of the coin manager.

**Note: MDB (Multi drop bus) interface information can be found on NAMA's website located at www.vending.org*

MEI
1301 Wilson Drive
West Chester, PA 19380
Technical Support 1(800)345-8172
Customer Support 1(800)345-8215
<http://www.meiglobal.com>



INSTALLATION INSTRUCTIONS

Before you begin...

- Remove the coin manager from the packaging material. Inspect unit for physical damage that may have occurred during shipping.
- Turn OFF the power supply to the vending machine.
- Push and hold the yellow button on the top right (below reject lever) of the coin manager and tilt the acceptor assembly forward. You do not have to remove the cassette (See Fig 1).
- Once open, the mounting holes are accessible. Hang the coin manager on the mounting studs/screws, ensuring that the changer is mounted on all three studs/screws (See Fig 2).
- Tighten screws (if required) and close the acceptor assembly.

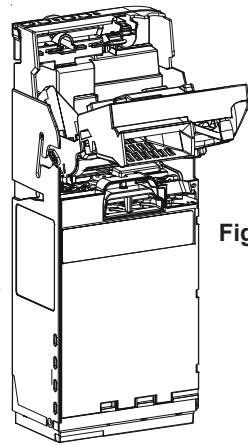

Fig. 1

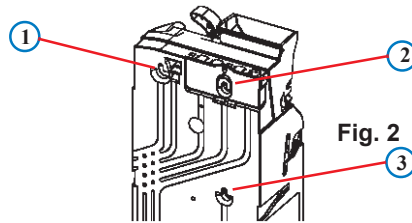
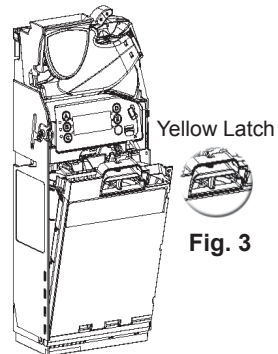
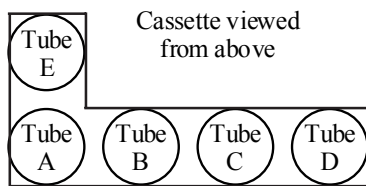

Fig. 2

- Remove cassette by sliding two fingers in the yellow latch and lift the cassette outwards and upwards as shown in Fig. 3.
- Manually fill cassette with coins. Insure that coins are inserted into the proper tubes.



Yellow Latch

Fig. 3

Notes

CASSETTE

The coin manager can be ordered with one of several cassette configurations:

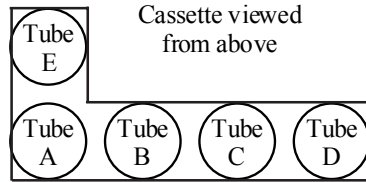

USA Cassettes

Key Code	Tube A	Tube B	Tube C	Tube D	Tube E
AA	10	5	25	25	5
AB	10	5	25	\$1	5
BA	25	5	25	25	25
BB	10	5	10	25	5
CC	Custom cassette 1 – defined in factory or by service tool				
CD	Custom cassette 2 – define yourself using cassette teach				
DAC	25	5	\$1	\$1	25
DCA	25	10	25	\$1	5
DCB	25	10	\$1	\$1	5
DCC	25	10	25	25	5
DCD	5	10	10	10	5
DCE	10	10	10	10	5

The coin manager can also be custom configured by removing any of the coin tubes and replacing them with another denomination tube. But there are restrictions:

Always include at least one 5c tube in all custom configured cassettes.

Do not place the \$1 tube in tube A or B position.

Do not place the 25 cent tube in tube B position.

Do not place the 10 cent tube in tube E position.

Coin	Tube # & Base Color	Max Fill (\$) (by coin manager)	Manual Fill(\$) (do not fill more than)	Position In cassette
5c	22 Red	77 (\$3.85)	87 (\$4.35)	A,B,C,D,E
10c	20 White	115 (\$11.50)	127 (\$12.70)	A,B,C,D
25c	25 Black	84 (\$21.00)	96 (\$24.00)	A,C,D,E
\$1	27 Blue	69 (\$69.00)	81 (\$81.00)	C,D,E

For additional instructions on tube positioning, you may contact our help desk at 1-800-345-8172.

•Once the coin manager is installed, check that there is a small gap (2-4 mm) between the lever on the vending machine and the return lever on the coin manager (See Fig 4). Check that when you press the coin return lever on the machine door, it fully opens the acceptor lid on the coin manager, then returns smoothly without holding the lid open.

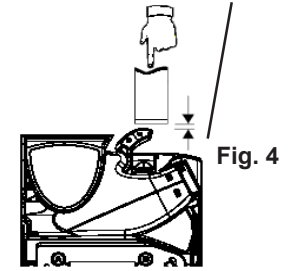

•Check the alignment of the coin input chute and cashbox chute. Insert some coins to check that they enter the coin manager properly and exit into the return cup (See Fig 5). Ensure that the coin chute does not rest on or open the flight deck lid.

Most machines allow you to adjust the return lever, coin chute, and the return cup to align with the coin manager. Align, adjust, and test as necessary to ensure coins are properly routed before continuing with these instructions.

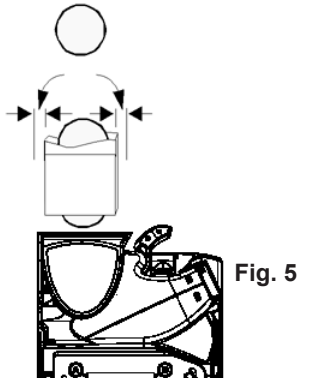

Connection

An MDB (Multi-Drop Bus) coin manager will be supplied with one or two harnesses. One connector transmits power and communication from the vending machine to the coin manager. The second harness allows for power and communication between the coin manager and another MDB device.

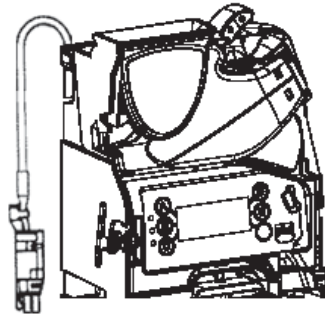

Coin manager with one harness...

- If you have a bill acceptor, connect the MDB harness coming from the coin

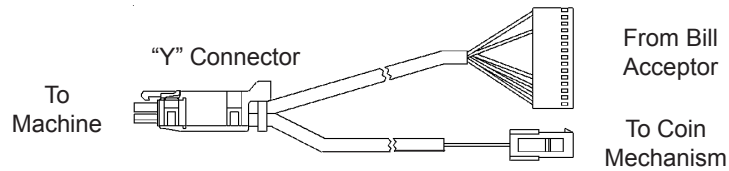

manager to the bill acceptor's "Y" connector.

If there is no bill acceptor, connect the coin manager harness to the harness coming from the machine's control board.

Coin manager with two harnesses... (Main and MDB Peripheral)

The purpose of having two harnesses (one male connector, one female socket), is that the 7512i coin manager has the ability to store bill acceptor audit data. The bill acceptor data can be viewed on the 7512i display. Connecting the bill

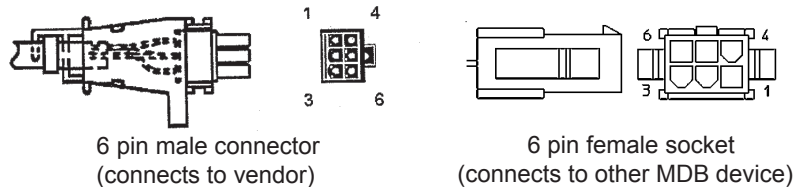

acceptor to the coin manager enhances the coin management capabilities.

- Disconnect the harness connecting the bill acceptor to the machine's control board. Attach the male connector coming from the coin manager to the female connector coming from the VMC. Attach the female connector from the coin manager to the bill acceptor's male connector.

- Tuck any excess length of harnessing inside the machine. Make sure all harnesses are not trapped when the coin return lever is pressed or when the vending machine door is closed.

- Now you may switch "ON" the power to the vending machine.

Service Mode Features (Continued)

AUDIT

If the yellow Mode Key is pressed twice in quick succession (with cassette in), then the display will show audit information.

Each message will be shown for 3 seconds. The screen can be frozen on the display by pressing "pause". The "pause" button will then alter to become a "resume" button (See Fig 13). When the "resume" button is pressed, the screens will continue to show, in sequence, the audit information.



Fig. 13

Audit information displayed:

Value of Cash to Cashbox
 Value of Cash to Tubes
 Value dispensed as change
 Value of manual dispense
 Total Tube value
 Tube A Count
 Tube B Count
 Tube C Count
 Tube D Count
 Tube E Count

Annualized Estimates follow

Sales Lost in Exact Change
 Percentage time in Exact Change
 Value of Sales in Exact Change
 Value of Sales with Change Available
 Number of Sales in Exact Change
 Number of Sales with Change Available
 Average Price with Change Available
 Time In Change
 Time With Change
 Time Disabled by VMC

End of Audit

Service Mode Features (Continued)

The current item is shown on the top line.

If “up arrow” key is pressed, the next menu item is displayed.

If “down arrow” key is pressed, the previous menu item is displayed.

If “back” is pressed the previous menu level is displayed.

If “back” is held for more that 2 secs, it exits the service mode.

If no key is pressed for 45 secs, then it exits the service mode.

The setup menu allows you to:

View Messages (If Present)

Change PAR styles, PAR levels, PAR value, snap shot

Manage Change

Change Cassettes or Individual Tubes

Token Teach

Perform Self Test (Manual / Auto)

View Error Log

Change Audit Setup

Setup MDB Options

along with other features...

Initial Power Up (First Time Out of Box)

The coin manager will power up and check to see how many coins are in each tube. If the tubes are empty the coin manager will alert you which tubes are low (See figure 6). You should fill the three lowest coin value tubes with a minimum of five coins per tube (i.e. On a 5,5,25,10,25 configuration, you would have to fill tubes ACD).



Fig. 6

Once you've filled the cassette with coins, the coin manager will measure the tubes for 5 seconds and display a happy face, an “OK”, and the total amount of change in the tubes (See Fig. 7). Dispense some coins from each tube to check that all coins drop into the coin return cup properly.



Fig. 7

If **no** cassette has been defined, the coin manager, when powered up, will display a warning message indicating the cassette needs to be defined before the product will operate (See fig. 8).

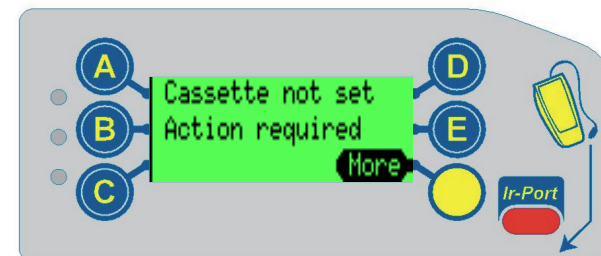

Fig. 8

The user has two options:

- Enter the cassette model located on the front of the cassette (i.e. AB). The unit may be ordered with one of the cassette configurations shown on page 10.
or
- Insert a valid coin then select the tube location (A-E) to which that specific coin is to be routed. Repeat procedure on all five tubes until all tubes have been assigned a coin. Press "Next", followed by "Accept".

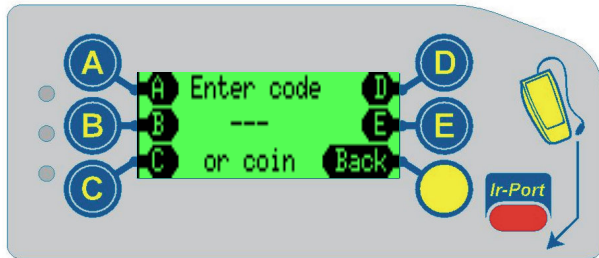

Fig. 9

Once you've defined the cassette, fill the cassette with coins. The coin manager will check tube capacity, then display a happy face, an "OK", and the total amount of change in the tubes (as shown in Fig. 7).

Service Menu

The yellow button below the "E" is the mode key. The mode key provides access to all of the features of the coin manager. When the yellow MODE key is pressed once, the user interface will enter Service Mode where features can be selected by pressing the keypad (See Fig 10).

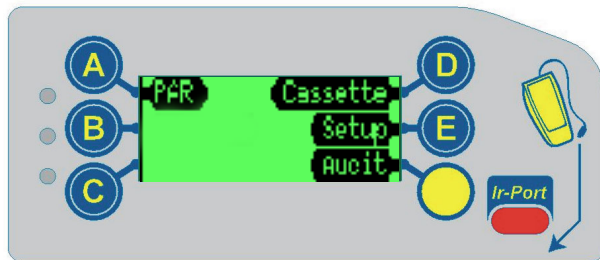

Fig. 10

After 5 seconds the screen will change slightly and the "audit" key will become the "Back" key.

Service Mode Features

PAR (Float)

The PAR default setting (comes set from the factory) is "PAR to Level". PAR to Level allows you set the level of each individual tube so that once the level is reached, further coins may be sent to the cash box. The default PAR Level (from factory) is full tubes. If you change the PAR setting to "PAR to Value". The default value is \$50. Par to value looks at the total value of coins in all five tubes. The PAR (or float) operation has three stages:

- Payout of any coins above the PAR
- Request insertion of coins that are below PAR
- Display Results

SETUP

After selecting the 'setup' button, a warning screen is displayed prompting a specific key sequence(ABC) to be entered to ensure that the setup menu is not accidentally entered (See Fig 11).

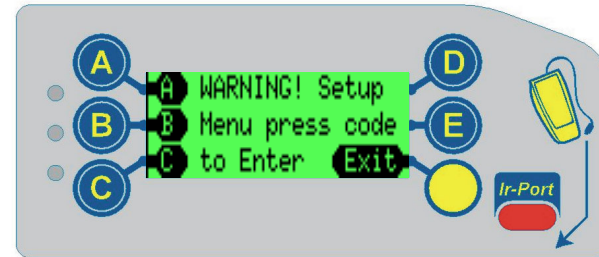

Fig. 11

When the setup menu has been entered it consists of a hierarchial menu that can be navigated using up and down keys to locate the required sub menu (See Fig 12).

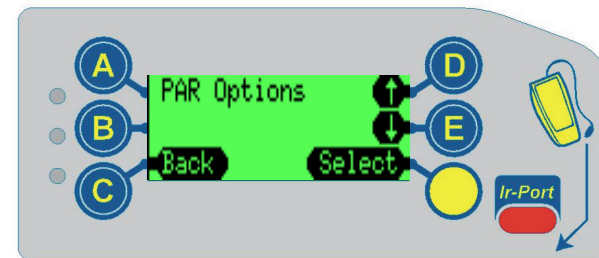

Fig. 12